

# **Prediction of Solar Cycle 24**

**Leif Svalgaard  
Ed W. Cliver**

**(Lund, 20 September 2005)**

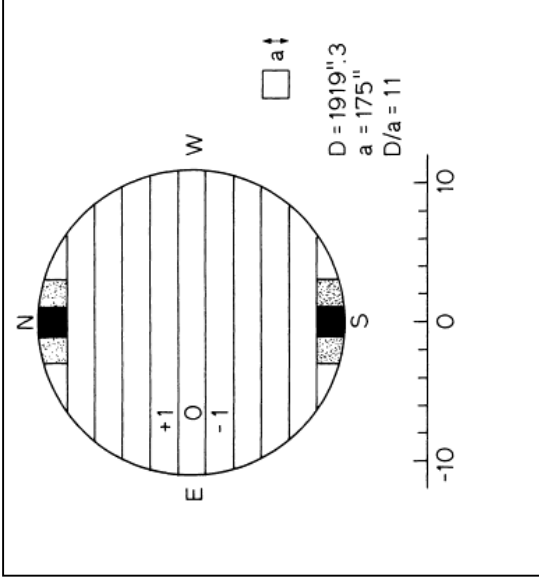

**Wilcox Solar Observatory (WSO)**

**Large aperture: 3'**

**Operational Definition of Polar Fields:**  
*Average field in pole-most apertures (black squares)*

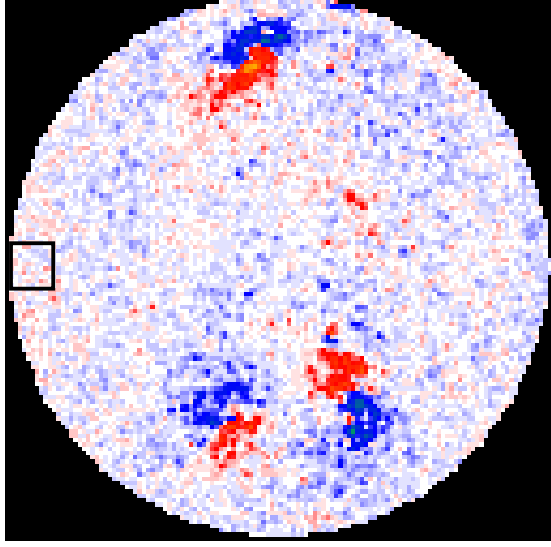

**Mount Wilson Observatory (MWO)**

**Small aperture: 0.2'**

**Operational Definition of Polar Fields:**  
*Average field of pixels inside aperture that matches that of WSO*

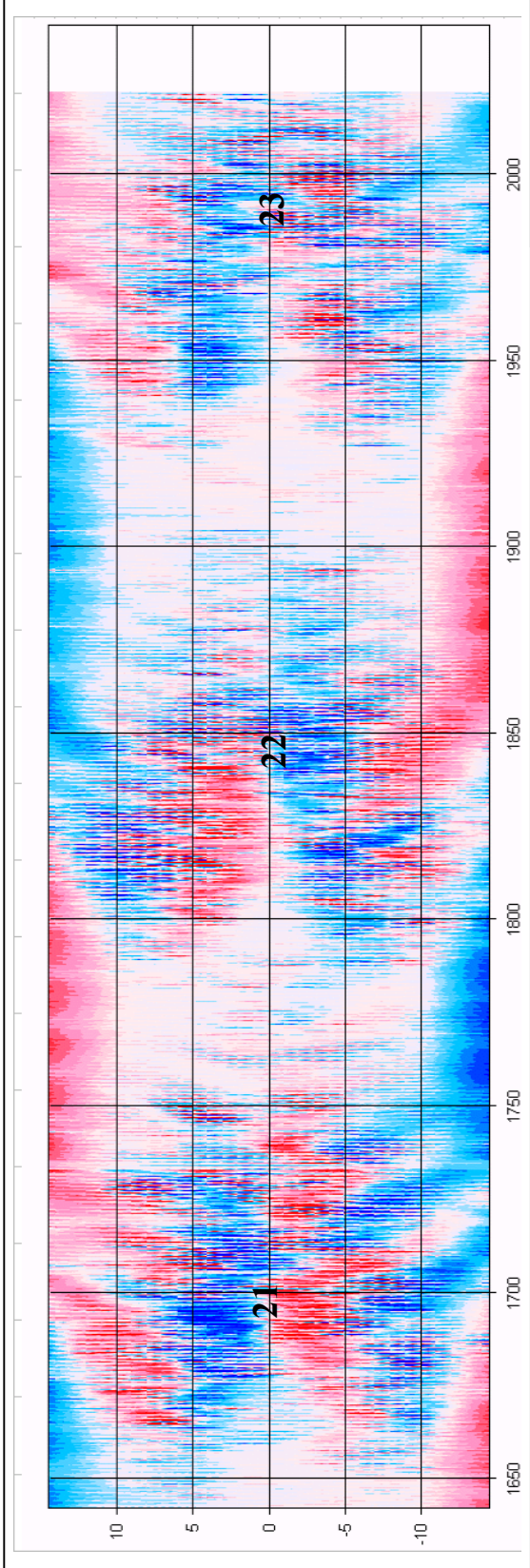

**Carrington Rotations**  
 $\leq$  MWO (Ulrich)

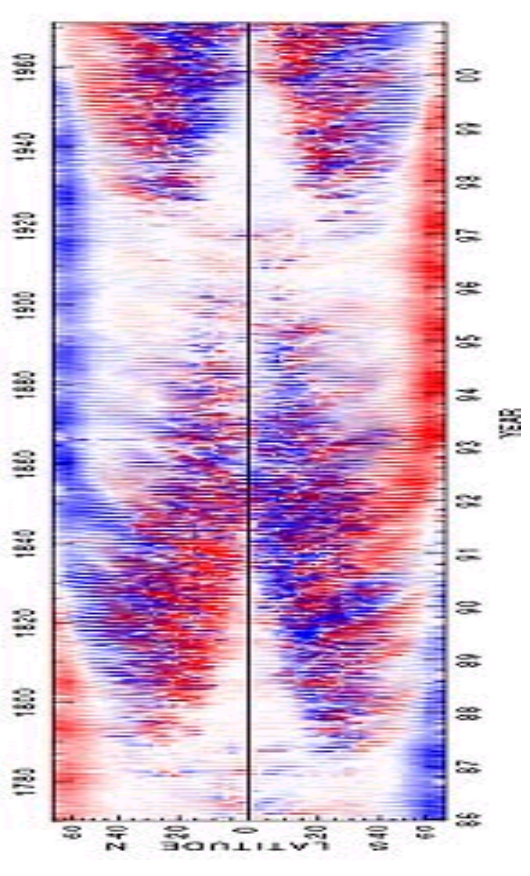

**“Super-synoptic Chart (WSO, above) showing three solar cycles.**  
**In spite of different apertures, same large-scale structures and evolution. Note the annual modulation of the polar fields.**

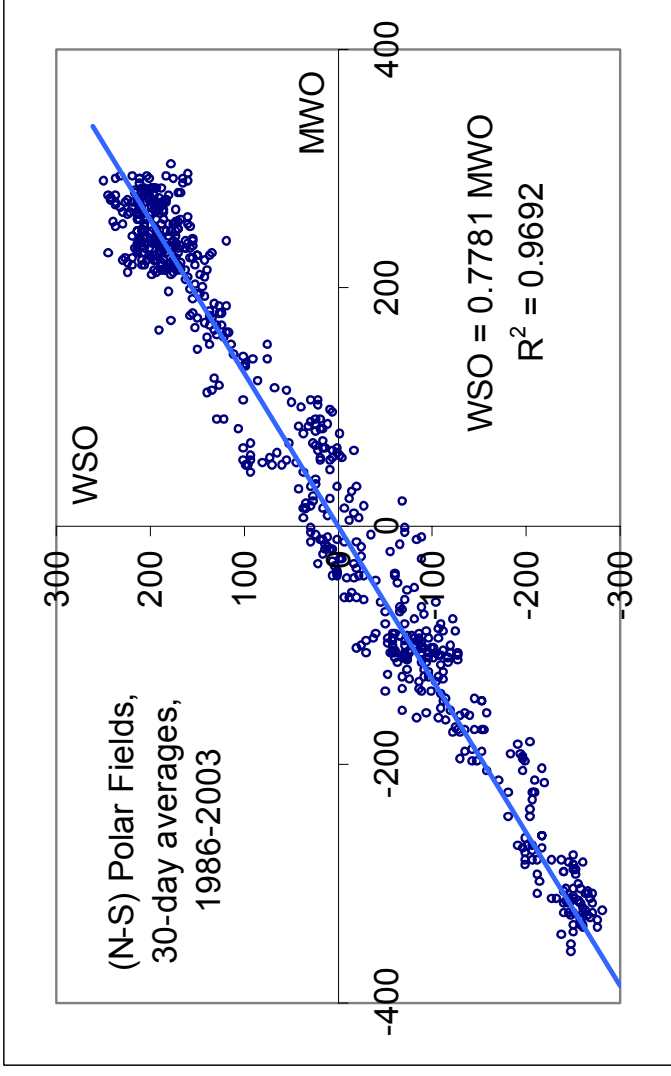

**A measure of the “dipole moment” is the difference between the polar fields in the two hemispheres (North and South). Taking the difference also compensates for zero-level errors. In spite of the difference in apertures (3’ for WSO and 0.2’ for MWO), the two observatories agree very well ( $R^2 = 0.97$ ). Before the upgrade of MWO in late 1985, the relationship was different:  $WSO = 1.325 MWO$ .**

**We can now reduce MWO polar fields to the WSO scale. Before 1983, MWO is noisy and has at times large zero-level errors. Before 1980, WSO suffered from scattered light (dirty optics!). So, early data before 1983 are less reliable. From 1986 on, the two observatories agree closely. Here we show the difference (N-S) and the sum (N+S) of the polar fields:**

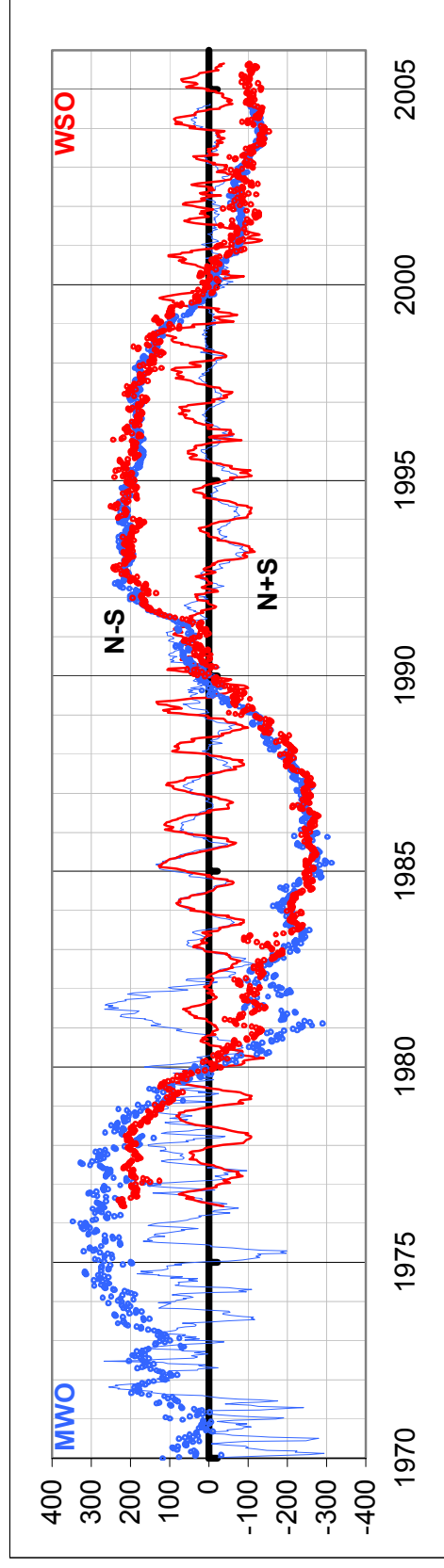

**The difference (N-S) shows a measure of the dipolar fields because the annual modulation cancels out, while the sum (N+S) shows a measure of the annual modulation because the solar dipole cancels out. Just after dipole reversal, the annual modulation is not present, but as we approach sunspot minimum (where the dipole is strongest), the modulation sets in.**

After the polar field reversal in 2000, the polar fields are still weak. In late 2003, the annual modulation again becomes well established:

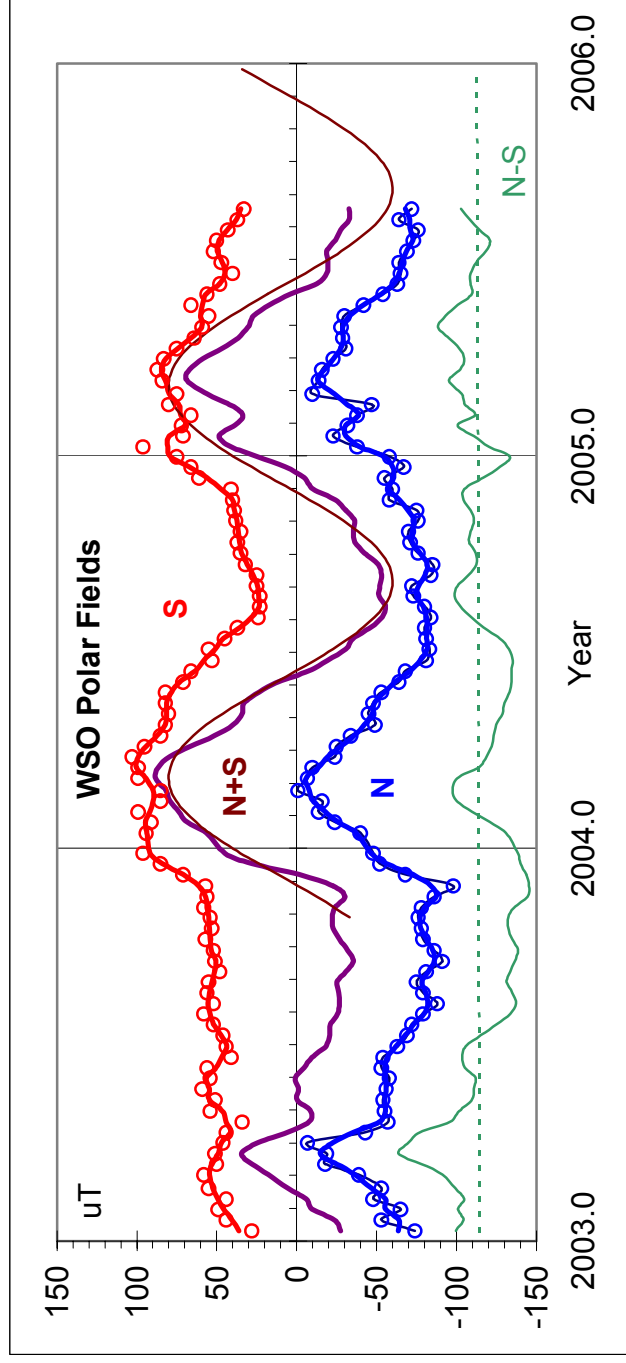

The “Polar Field Precursor” prediction method (Schatten *et al.*, GRL, 1978) presumes that the strength of the solar magnetic axial dipole determines the size of the following solar cycle. Svalgaard *et al.*, (GRL, 2005) propose to use as a measure of the strength of the dipole its average value over three years following the time of establishment of the annual modulation. During this time, the observed polar fields are stable and well defined.

The annual modulation is a geometrical “artifact” caused by the polar fields being highly concentrated very near the pole [ $B = B_P \sin^8(\text{latitude})$ ] in combination with the 7.25 degree angle between the sun’s equator and the ecliptic and with line-of-sight foreshortening. The measured polar field is only the line-of-sight component of the “real” field as seen by the magnetographs. No corrections for foreshortening or magnetograph “saturation” (whatever causes that) have been applied. In the remaining Figures, the *sign* of the polar fields for 1993.5-1996.5 has been reversed for easier comparison with surrounding cycles.

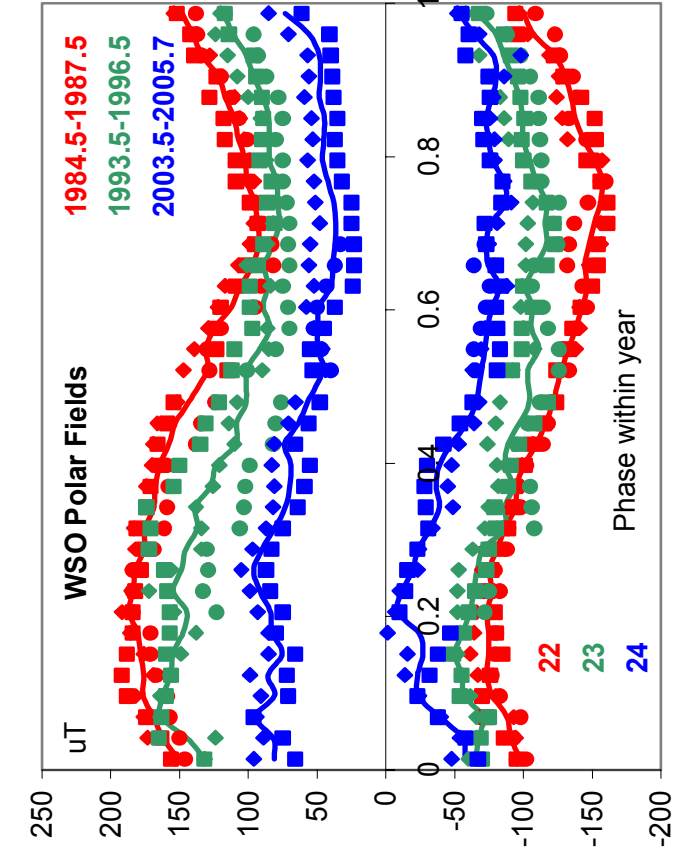

Here we show the modulation for each year (diamonds, squares, and circles) color-coded according to time intervals as indicated before the past three minima preceding the sunspot maxima of cycle 22 (red), 23 (green) and 24 (blue - and incomplete).

The modulation is a stable feature of the observed polar fields and has now been observed for four solar cycles. Once the modulation starts it continues unchanged until abruptly disappearing at the next polar field reversal.

For the prediction of the cycle, the annual modulation as such is not important. What is important is that the modulation seems to begin once stable and well-defined polar fields have been built up. The polar field precursor hypothesis posits that the axial dipolar field acts as a seed for the following cycle and that there is a relationship between the strength of the dipole and of the magnitude ( $R_{max}$ ) of the following cycle.

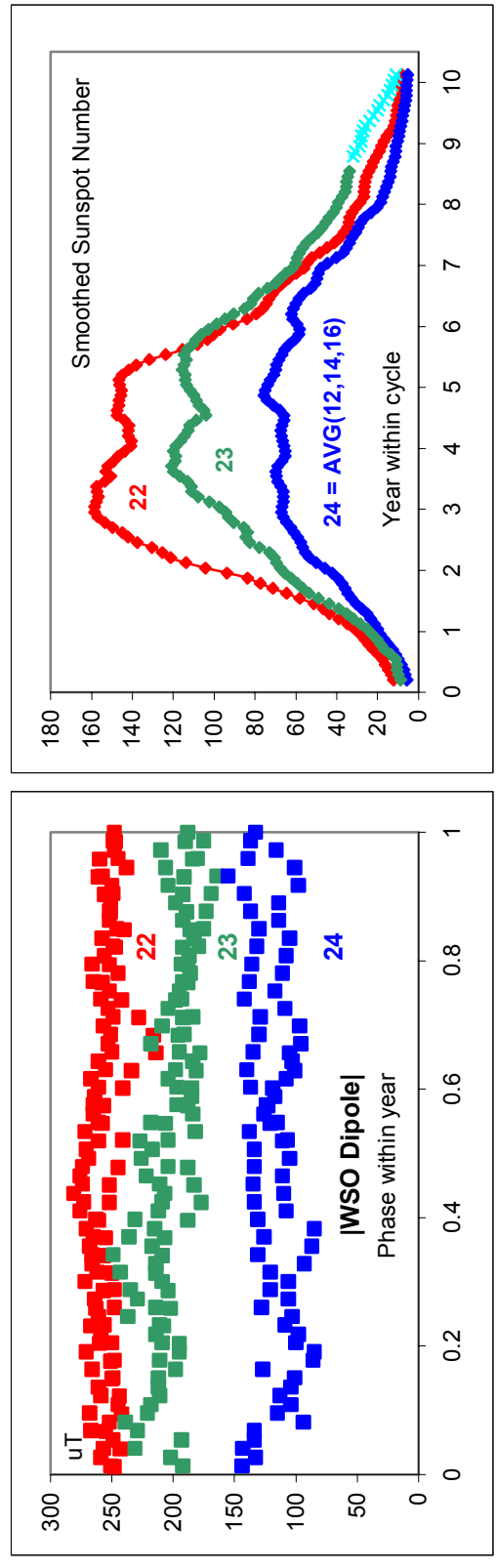

The left panel shows 30-day means of the axial dipole strength  $D = (N-S)$  spaced 10 days apart for each year of the three pre-minimum intervals before cycles 22 (red), 23 (green), and 24 (blue) as a function of the time within the year. The dipole appears stable within each interval (typical variation  $\pm 10\%$ ). For cycles 22 and 23 (and consistent with 21) the ratio  $R_{max}/D$  was  $\sim 0.63$ . Assuming that the same ratio holds for cycle 24 puts  $R_{max24}$  at 75 corresponding to the average of cycles 12, 14, and 16 of  $\sim 100$  years ago (right panel).

As is so clearly seen on super-synoptic charts, the polar fields are remnants of lower latitude flux drifting to or transported to the poles. One might surmise that the polar fields near solar minimum would then be some fraction of the magnetic flux from the *preceding* sunspot cycle, and therefore be useless in predicting the following cycle. The Babcocks (1955) found strong polar fields in 1952-1955 preceding the strong solar cycle 19. Severny (1964) reported that the polar fields in 1961-1963 (preceding the weak cycle 20) were at or below the noise level of his magnetograph. MWO data preceding cycle 21 suggest polar fields comparable to those preceding cycle 22, and we have just here reported on the later cycles. The following Figure summarizes all these results. It is apparent that the data at hand favor polar fields that anticipate the size of the following cycle:

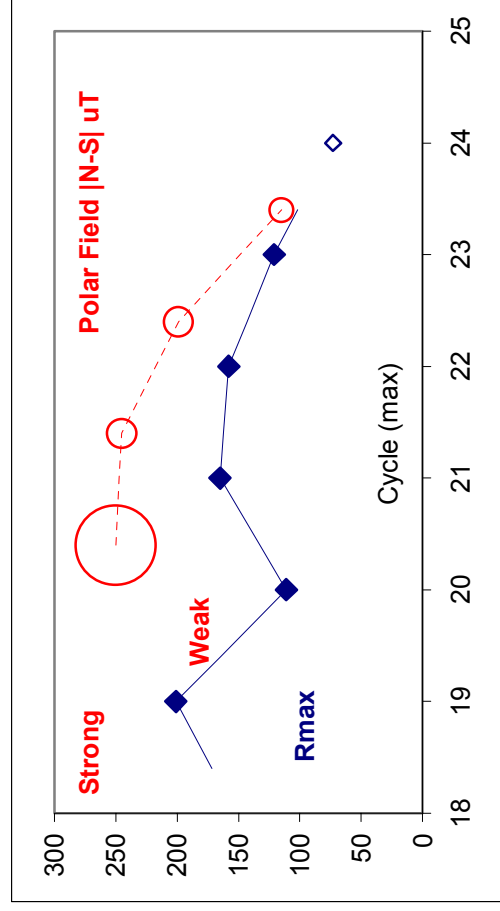

Nevertheless, cycle 24 will be a crucial test of the polar field precursor technique. As usual, we'll see predictions ranging all the way from Maunder Minimum conditions to  $R_{max}$  exceeding 200, so *someone* is going to be close (but not necessarily useless). We shall see...

The end